

SURELINE II Pipes

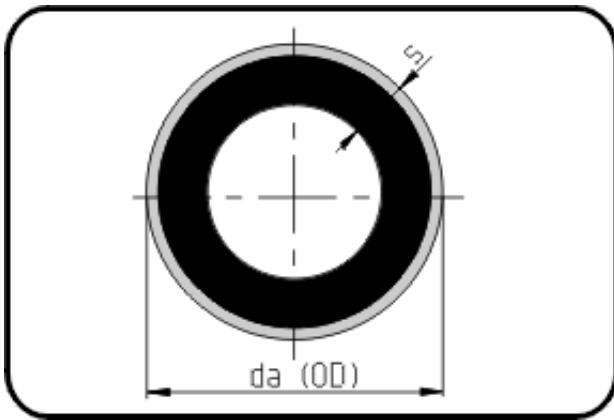

Code: 712.2

- Pipe black 12m
- with green signal layer
- extruded
- PE 100-RC SURELINE II

From dim. 250 not available from stock - delivery time on request.

Dimension	Code	Detail	Weight
1000	70.712.2100.17	1000X59,3 SDR17 ISO S-8	176.00

	Unit	Nominale	Tol+	Tol-
da(OD)	mm	1.000	0.00	0.00
s	mm	59,3	0.00	0.00