

Elongated Fittings

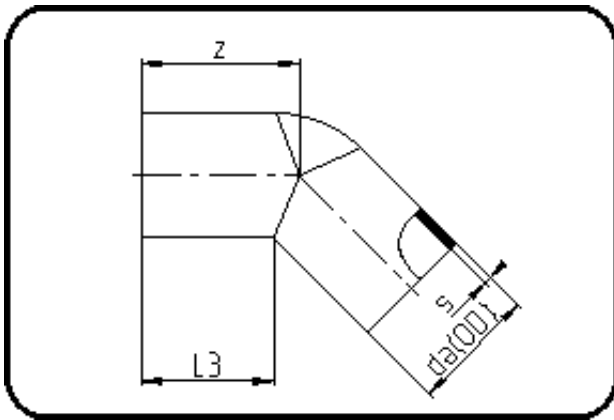

Code: 060

- Elbow 45°
- long spigot
- W/P-TW
- injection moulded
- **Butt + E-socket-welding**
- PE 100-RC black

Dimension	Code	Detail	Weight
250	70.060.0250.17	250X14,8 SDR17 PN10	5.00

	Unit	Nominale	Tol+	Tol-
da(OD)	mm	250	1.50	0.00
L3	mm	158	3.00	3.00
s	mm	14,8	1.60	0.00
z	mm	217	3.00	3.00