

Saddles

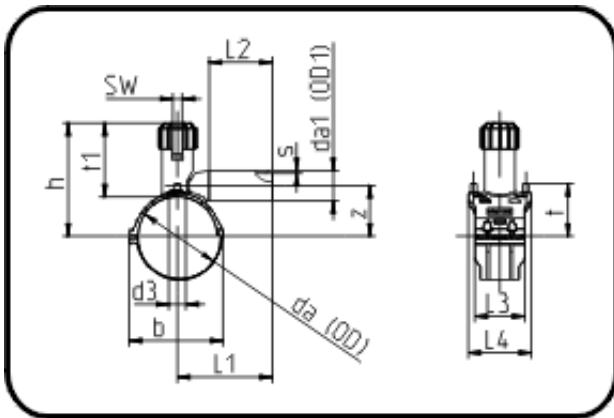

Code: 278

- Tapping Saddle with screw cap
- gastight-bottom part screwable
- injection moulded
- **Electro-fusion**
- **PE 100-RC black**

Dimension	Code	Detail	Weight
160/32	70.278.1632.11	160/32 SDR 17 - 11	0.89

	Unit	Nominale	Tol+	Tol-
s	mm	3	0.00	0.00
t	mm	108	0.00	0.00
t1	mm	152	0.00	0.00
z	mm	99	0.00	0.00
da(OD)	mm	160	0.00	0.00
L1	mm	130	0.00	0.00
SW	mm	17	0.00	0.00
L3	mm	103	0.00	0.00
L2	mm	92	1.50	1.50
L4	mm	131	0.00	0.00
b	mm	204	0.00	0.00
d3	mm	32	0.00	0.00
h	mm	231,5	0.00	0.00
da(OD1)	mm	32	0.00	0.00