

## Electro Fusion Fittings

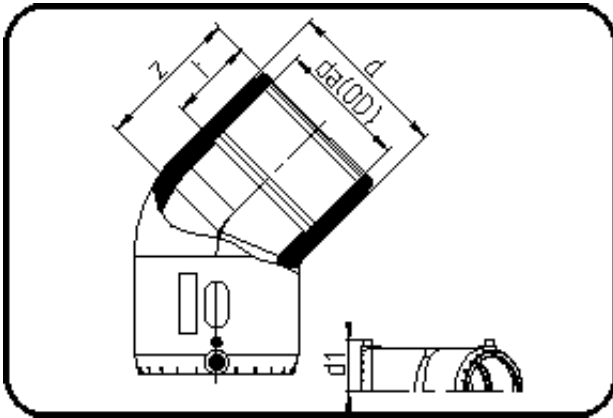

Code: 170

- **E-Elbow 45°**
- MOP water 16bar/gas 10bar
- W/P-TW
- injection moulded
- **Electro-fusion**
- **PE 100-RC black**

Dimension	Code	Detail	Weight
140	70.170.0140.11	140 SDR 17-11	1.92

	Unit	Nominale	Tol+	Tol-
da(OD)	mm	140	0.90	0.00
d	mm	173	1.00	1.00
d1	mm	97	1.00	1.00
t	mm	89	2.25	2.25
z	mm	128	1.50	1.50