

SURELINE II Pipes

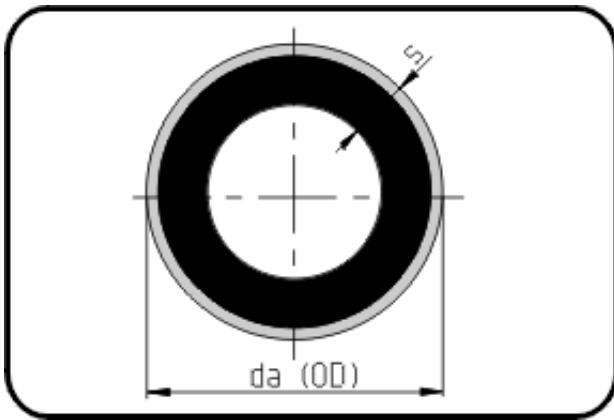

Code: 712.2

- Pipe black 12m
- with green signal layer
- extruded
- PE 100-RC SURELINE II

From dim. 250 not available from stock - delivery time on request.

Dimension	Code	Detail	Weight
500	70.712.2500.17	500X29,7 SDR17 ISO S-8	44.20

	Unit	Nominale	Tol+	Tol-
da(OD)	mm	500	0.00	0.00
s	mm	29,7	0.00	0.00