

SURELINE II Pipes

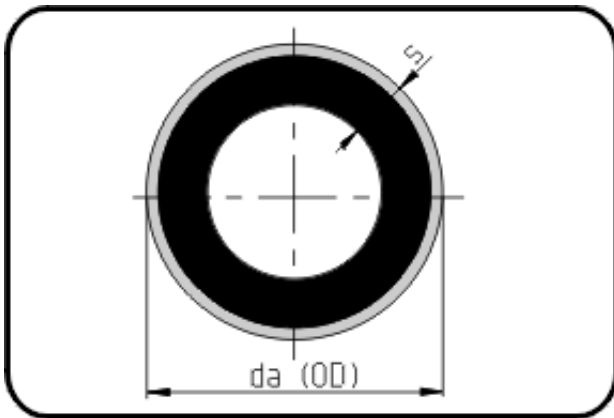

Code: 712.2

- Pipe black 12m
- with green signal layer
- extruded
- PE 100-RC SURELINE II

From dim. 250 not available from stock - delivery time on request.

Dimension	Code	Detail	Weight
355	70.712.2355.11	355X32,2 SDR11 ISO S-5	32.90

	Unit	Nominale	Tol+	Tol-
da(OD)	mm	355	2.20	0.00
s	mm	32,2	3.40	0.00