

Fittings with short Spigot

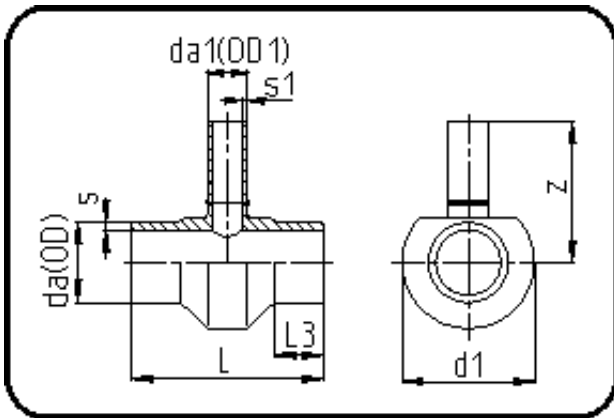

Code: 307

- Tee reduced
- short spigot
- machined
- **Butt-welding**
- PE 100-RC black

Dimension	Code	Detail	Weight
500/280	70.307.5028.09	500/280 SDR9 ISO S-4	47.00

	Unit	Nominale	Tol+	Tol-
da(OD)	mm	500	4.50	0.00
L	mm	510	3.00	3.00
L3	mm	75	1.00	1.00
s	mm	55,8	5.70	0.00
d1	mm	618	1.00	1.00
s1	mm	31,3	3.30	0.00
da(OD1)	mm	280	2.60	0.00
z	mm	425	3.00	3.00