

SURELINE II Pipes

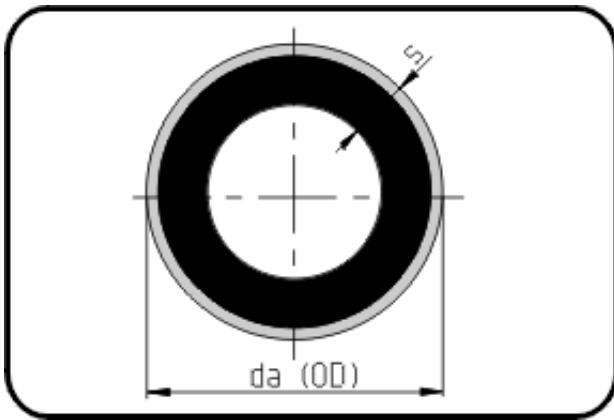

Code: 712.2

- Pipe black 12m
- with green signal layer
- extruded
- PE 100-RC SURELINE II

From dim. 250 not available from stock - delivery time on request.

Dimension	Code	Detail	Weight
630	70.712.2630.17	630X37,4 SDR17 ISO S-8	70.20

	Unit	Nominale	Tol+	Tol-
da(OD)	mm	630	0.00	0.00
s	mm	37,4	0.00	0.00