

PE 100-RC Poly-Flo

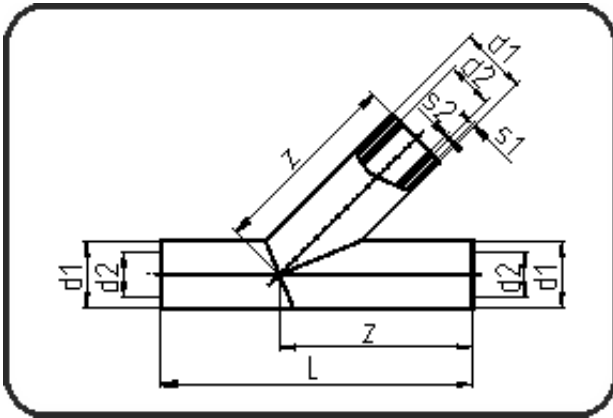

Code: 192.1

- Poly-Flo Lateral
- derating factor 0.5
- segmented
- **simultaneous + cascade welding**
- PE 100-RC black

Dimension	Code	Detail	Weight
160/110	70.192.1612.37	160/110 SDR33/17	3.73

	Unit	Nominale	Tol+	Tol-
L	mm	550	15.00	15.00
d1	mm	160	1.50	0.00
s2	mm	6,6	1.10	0.00
d2	mm	110	1.50	0.00
s1	mm	4,9	1.10	0.00
z	mm	350	7.50	7.50