

Backing Rings, Accessories

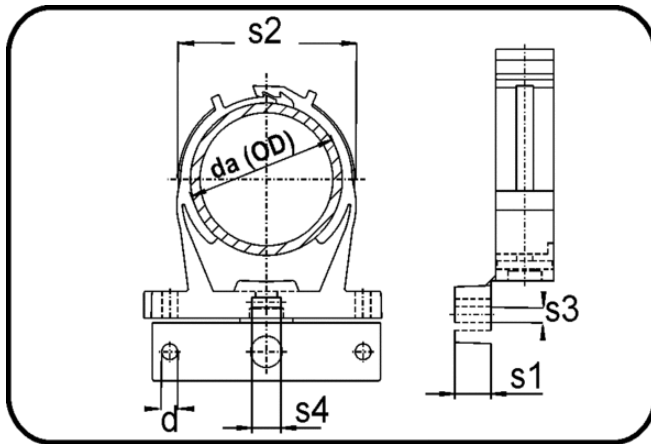

Code: 348

- Pipe Support
- injection moulded
- Installation Accessory
- PP-FRP black

Dimension	Code	Detail	da(OD) mm	s1 mm	s2 mm	s3 mm	s4 mm	d mm	Weight
20	14.348.0020.00	20	20	6	29	6,5	9	6,5	0.01
25	14.348.0025.00	25	25	10	34	6,5	9	6,5	0.01
32	14.348.0032.00	32	32	11,5	39	6,5	9	6,5	0.02
40	14.348.0040.00	40	40	14	50	6,5	9	6,5	0.02
50	14.348.0050.00	50	50	15	56	6,5	9	6,5	0.03