

MULTI Fittings

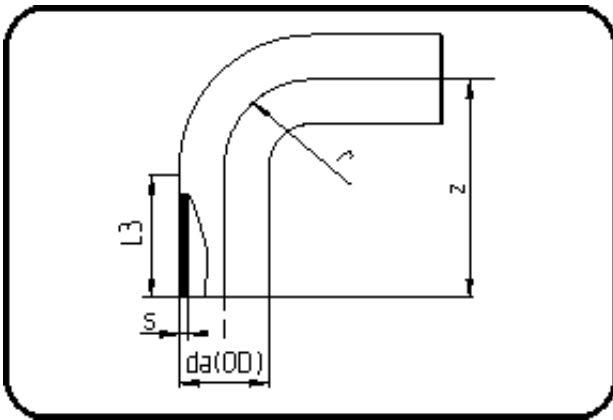

Code: 068

- **MULTI-Bend 90°**
- long spigot
- injection moulded
- **Butt + E-socket-welding**
- **PPR grey**

Dimension	Code	Detail	Weight
63	11.068.0063.11	63X5,8 SDR11 ISO S-5	0.25

	Unit	Nominale	Tol+	Tol-
da(OD)	mm	63	0.60	0.00
L3	mm	66,5	3.00	3.00
r	mm	63	0.00	0.00
s	mm	5,8	0.70	0.00
z	mm	129,5	4.50	4.50