

MULTI Fittings

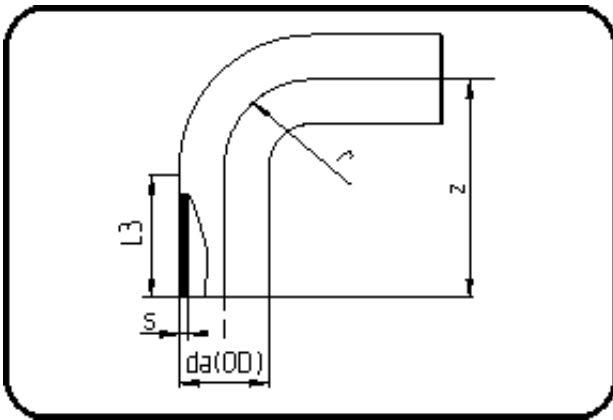

Code: 068

- **MULTI-Bend 90°**
- long spigot
- injection moulded
- **Butt + E-socket-welding**
- **PPR grey**

Dimension	Code	Detail	Weight
280	11.068.0280.11	280X25,4 SDR11 ISO S-5	14.22

	Unit	Nominale	Tol+	Tol-
da(OD)	mm	280	2.60	0.00
L3	mm	146	6.00	6.00
r	mm	280	0.00	0.00
s	mm	25,4	2.70	0.00
z	mm	429	5.00	5.00