

Segmented Fittings

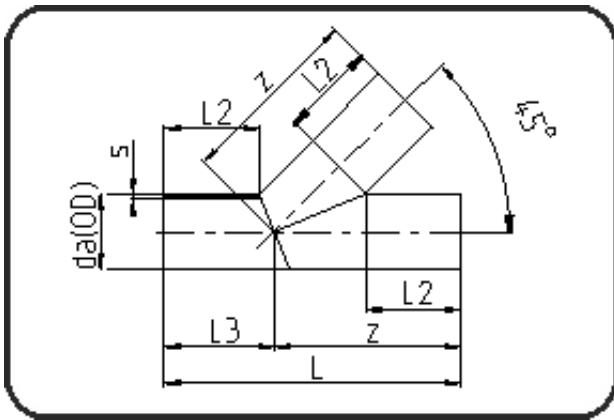

Code: 325

- Tee 45°
- segmented
- derating factor 0.5
- **Butt + E-socket-welding**
- PPH grey

Dimension	Code	Detail	Weight
355	12.325.0355.11	355X32,2 SDR11 ISO S-5	61.70

	Unit	Nominale	Tol+	Tol-
da(OD)	mm	355	0.00	0.00
L	mm	1.203	30.00	30.00
L3	mm	424	0.00	0.00
L2	mm	350	0.00	0.00
s	mm	32,2	0.00	0.00
z	mm	779	30.00	30.00