

MULTI Fittings

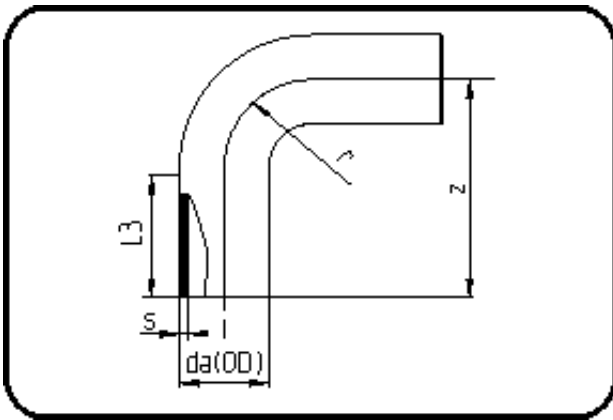

Code: 068

- **MULTI-Bend 90°**
- long spigot
- injection moulded
- **Butt + IR-welding**
- **ECTFE natural**

Dimension	Code	Detail	Weight
32	40.068.0032.21	32X2,4 SDR21 ISO S-10	0.05

	Unit	Nominale	Tol+	Tol-
da(OD)	mm	32	0.30	0.00
L3	mm	33	1.50	1.50
r	mm	32	0.00	0.00
s	mm	2,4	0.50	0.00
z	mm	63	1.50	1.50