

Fittings with short Spigot

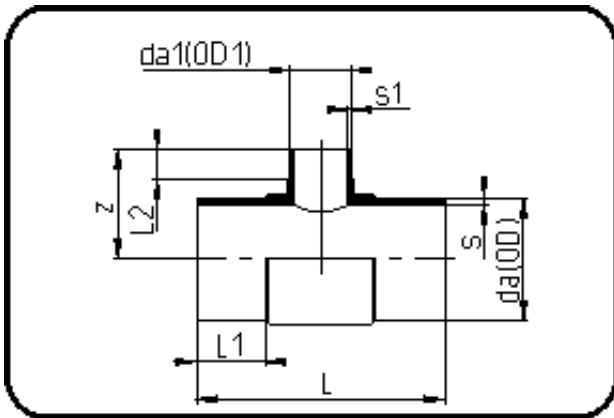

Code: 016

- Tee reduced
- short spigot
- injection moulded
- **Butt-welding**
- PPR grey

Dimension	Code	Detail	Weight
90/32	11.016.9032.11	90/32 SDR11 ISO S-5	0.56

	Unit	Nominale	Tol+	Tol-
da(OD)	mm	90	0.90	0.00
L	mm	213	4.50	4.50
L1	mm	57	2.25	2.25
L2	mm	23	1.50	1.50
s	mm	8,2	1.00	0.00
s1	mm	2,9	0.50	0.00
da(OD1)	mm	32	0.30	0.00
z	mm	85	3.00	3.00