

PE 100-RC Poly-Flo

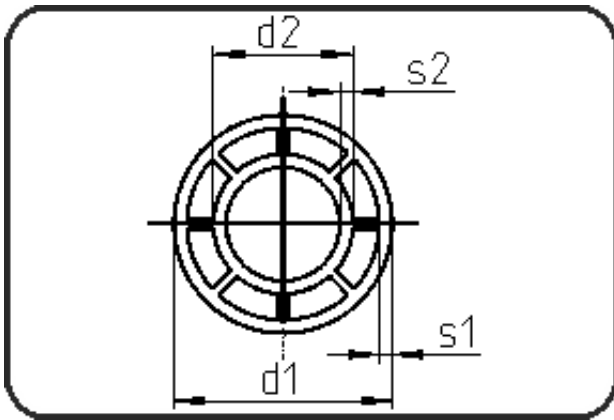

Code: 785.1

- Poly-Flo Pipe 5m (16.4')
- extruded
- **simultaneous + cascade welding**
- PE 100-RC black

Dimension	Code	Detail	Weight
160/110	70.785.1611.37	160/110 SDR33/17	4.69

	Unit	Nominale	Tol+	Tol-
d1	mm	160	1.50	0.00
s2	mm	6,6	0.80	0.00
d2	mm	110	1.05	0.00
s1	mm	4,9	0.60	0.00