

MULTI Fittings

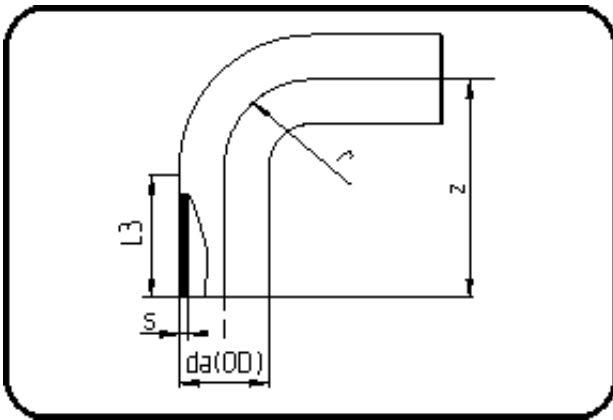

Code: 068

- **MULTI-Bend 90°**
- long spigot
- injection moulded
- **Butt + E-socket-welding**
- **PPR grey**

Dimension	Code	Detail	Weight
225	11.068.0225.17	225X13,4 SDR17 ISO S-8	5.81

	Unit	Nominale	Tol+	Tol-
da(OD)	mm	225	2.10	0.00
L3	mm	125	6.00	6.00
r	mm	225	0.00	0.00
s	mm	13,4	1.50	0.00
z	mm	353	7.50	7.50