

Fittings

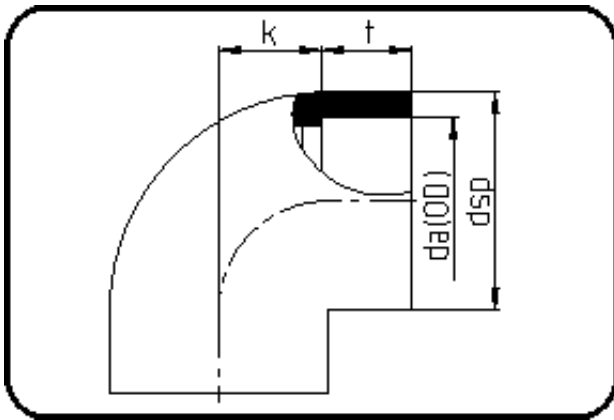

Code: 051

- Elbow 90°
- injection moulded
- **Socket-welding**
- PE 100 blue

Dimension	Code	Detail	Weight
25	22.051.0025.07	25 - MOP 16 bar	0.03

	Unit	Nominale	Tol+	Tol-
da(OD)	mm	25	0.00	0.00
dsp	mm	35,1	0.75	0.75
t	mm	18	0.75	0.75
p	bar	16	0.00	0.00
k	mm	17	0.75	0.75