

PE 100-RC Poly-Flo

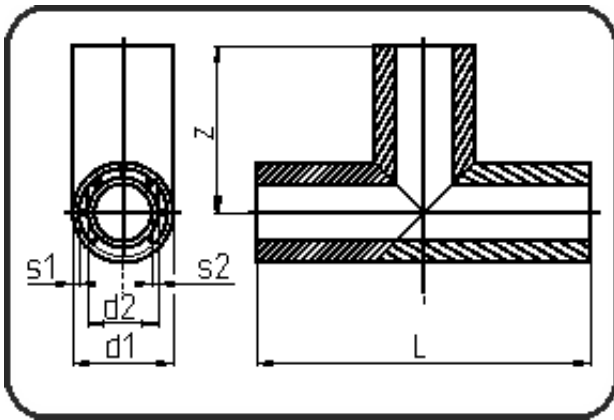

Code: 214

- Poly-Flo Tee
- derating factor 0.6
- segmented
- **simultaneous + cascade welding**
- PE 100-RC black

Dimension	Code	Detail	Weight
160/110	70.214.1611.37	160/110 SDR33/17	2.70

	Unit	Nominale	Tol+	Tol-
L	mm	400	6.00	6.00
L1	mm	10	1.00	1.00
d1	mm	160	1.50	0.00
s2	mm	6,6	0.80	0.00
d2	mm	110	1.00	0.00
s1	mm	4,9	0.60	0.00
z	mm	200	6.00	6.00