

MULTI Fittings

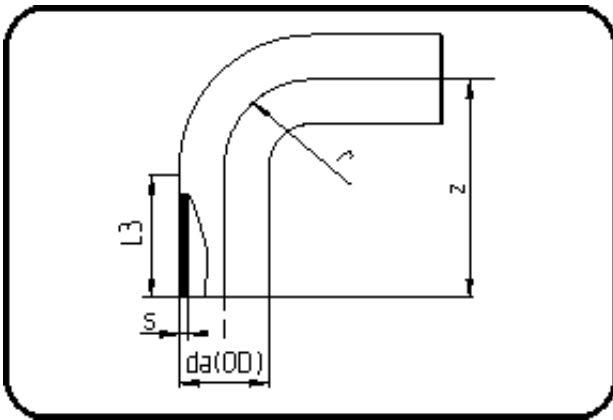

Code: 068

- **MULTI-Bend 90°**
- long spigot
- injection moulded
- **Butt + E-socket-welding**
- **PPR grey**

Dimension	Code	Detail	Weight
140	11.068.0140.17	140X8,3 SDR17 ISO S-8	1.58

	Unit	Nominale	Tol+	Tol-
da(OD)	mm	140	1.30	0.00
L3	mm	100	4.50	4.50
r	mm	140	0.00	0.00
s	mm	8,3	1.00	0.00
z	mm	241	6.00	6.00