

MULTI Fittings

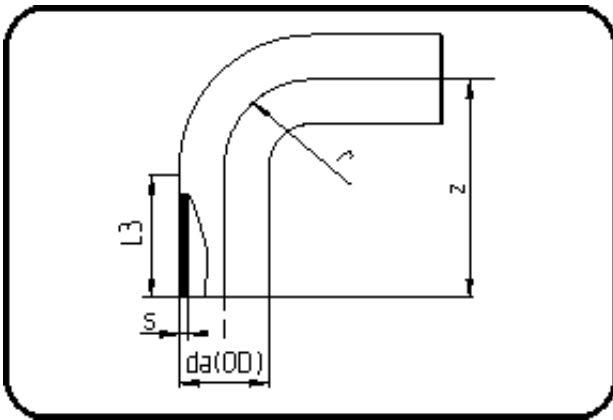

Code: 068

- **MULTI-Bend 90°**
- long spigot
- injection moulded
- **Butt + E-socket-welding**
- **PPR grey**

Dimension	Code	Detail	Weight
250	11.068.0250.17	250X14,8 SDR17 ISO S-8	7.04

	Unit	Nominale	Tol+	Tol-
da(OD)	mm	250	2.30	0.00
L3	mm	135	6.00	6.00
r	mm	250	0.00	0.00
s	mm	14,8	1.60	0.00
z	mm	389	5.00	5.00