

PE 100-RC Poly-Flo

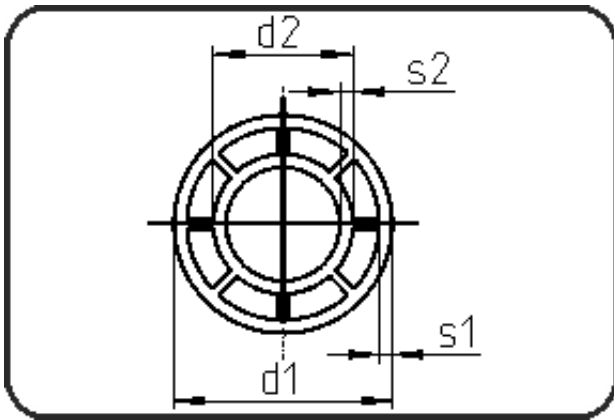

Code: 785.1

- Poly-Flo Pipe 5m (16.4')
- extruded
- **simultaneous + cascade welding**
- PE 100-RC black

Dimension	Code	Detail	Weight
225/160	70.785.2216.71	225/160 SDR17/11	15.43

	Unit	Nominale	Tol+	Tol-
d1	mm	225	1.40	0.00
s2	mm	14,6	1.60	0.00
d2	mm	160	1.00	0.00
s1	mm	13,4	1.50	0.00