

## Fittings with short Spigot

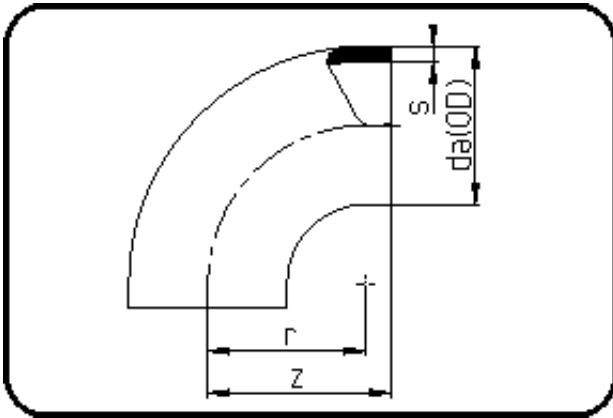

Code: 001

- Bend 90°
- short spigot
- injection moulded
- **Butt-welding**
- PPR grey

Dimension	Code	Detail	Weight
280	11.001.0280.17	280X16,6 SDR17 ISO S-8	6.20

	Unit	Nominale	Tol+	Tol-
da(OD)	mm	280	2.60	0.00
r	mm	265	0.00	0.00
s	mm	16,6	1.80	0.00
z	mm	290	6.00	6.00