

MULTI Fittings

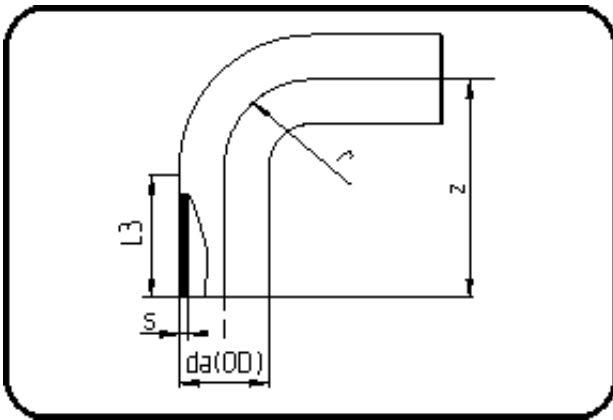

Code: 068

- **MULTI-Bend 90°**
- long spigot
- injection moulded
- **Butt + E-socket-welding**
- **PPR grey**

Dimension	Code	Detail	Weight
50	11.068.0050.11	50X4,6 SDR11 ISO S-5	0.13

	Unit	Nominale	Tol+	Tol-
da(OD)	mm	50	0.50	0.00
L3	mm	58,5	3.00	3.00
r	mm	50	0.00	0.00
s	mm	4,6	0.60	0.00
z	mm	108,5	4.50	4.50