

## Fittings with short Spigot

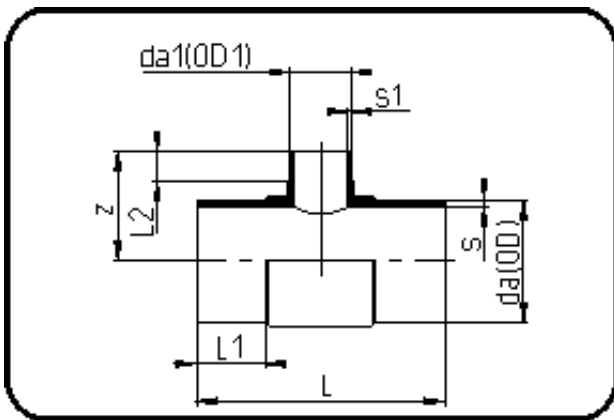

Code: 016

- Tee reduced
- short spigot
- injection moulded
- **Butt-welding**
- PPR grey

Dimension	Code	Detail	Weight
140/63	11.016.1463.17	140/63 SDR17 ISO S-8	1.31

	Unit	Nominale	Tol+	Tol-
da(OD)	mm	140	1.30	0.00
L	mm	302	4.50	4.50
L1	mm	86	3.75	3.75
L2	mm	32	1.50	1.50
s	mm	8,3	1.00	0.00
s1	mm	3,8	0.50	0.00
da(OD1)	mm	63	0.60	0.00
z	mm	120	3.00	3.00