

Fittings

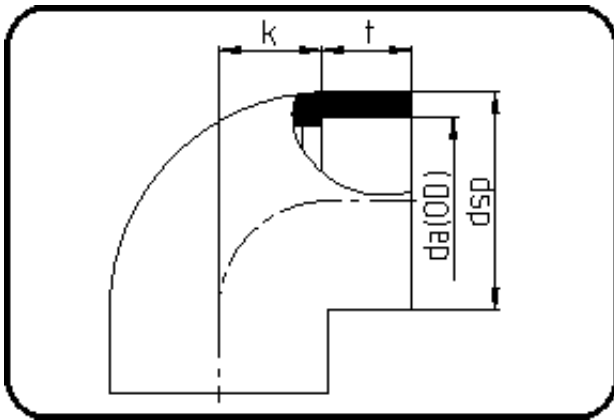

Code: 051

- Elbow 90°
- injection moulded
- Socket-welding
- PE 100 blue

Dimension	Code	Detail	Weight
50	22.051.0050.07	50 - MOP 16 bar	0.14

	Unit	Nominale	Tol+	Tol-
da(OD)	mm	50	0.00	0.00
dsp	mm	65	0.75	0.75
t	mm	25	1.50	1.50
p	bar	16	0.00	0.00
k	mm	28	0.75	0.75