

Fittings

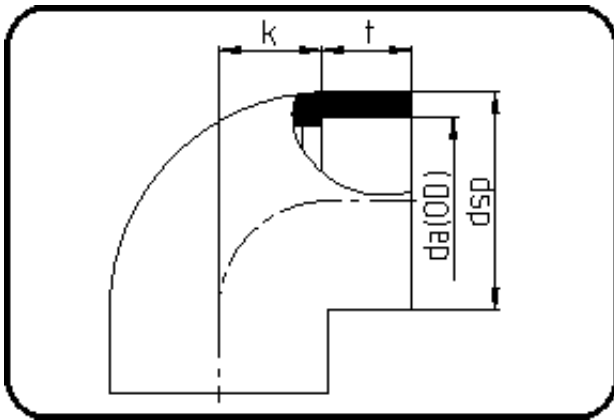

Code: 051

- Elbow 90°
- injection moulded
- Socket-welding
- PE 100 blue

Dimension	Code	Detail	Weight
75	22.051.0075.07	75 - MOP 16 bar	0.32

	Unit	Nominale	Tol+	Tol-
da(OD)	mm	75	0.00	0.00
dsp	mm	92	0.75	0.75
t	mm	32	0.75	0.75
p	bar	16	0.00	0.00
k	mm	39	0.75	0.75