

Fittings with short Spigot

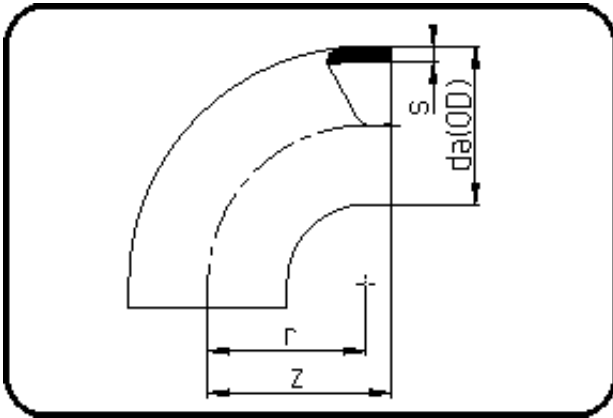

Code: 001

- Bend 90°
- short spigot
- injection moulded
- **Butt-welding**
- PPR grey

Dimension	Code	Detail	Weight
500	11.001.0500.11	500X45,4 SDR11 ISO S-5	44.46

	Unit	Nominale	Tol+	Tol-
da(OD)	mm	500	4.50	0.00
r	mm	400	0.00	0.00
s	mm	45,4	4.70	0.00
z	mm	445	7.50	7.50