

## PP/PP Simultaneous Welding

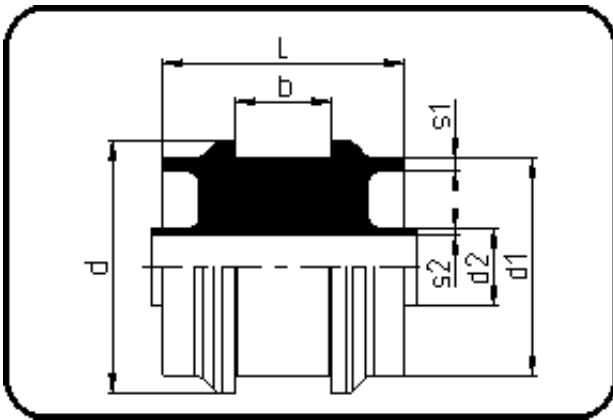

Code: 139

- Dog Bone Type II, Collar
- without cut out
- machined
- **Simultaneous-welding**
- **PP/PP**

Dimension	Code	Detail	Weight
315/200	80.139.3120.31	315/200 SDR33/11	5.43

	Unit	Nominale	Tol+	Tol-
L	mm	150	1.50	1.50
b	mm	65	0.00	0.00
d	mm	340	0.00	0.00
d1	mm	315	0.00	0.00
SDR2		11	0.00	0.00
SDR1		33	0.00	0.00
s2	mm	18,2	0.00	0.00
d2	mm	200	0.00	0.00
s1	mm	9,7	0.00	0.00