

Fittings with short Spigot

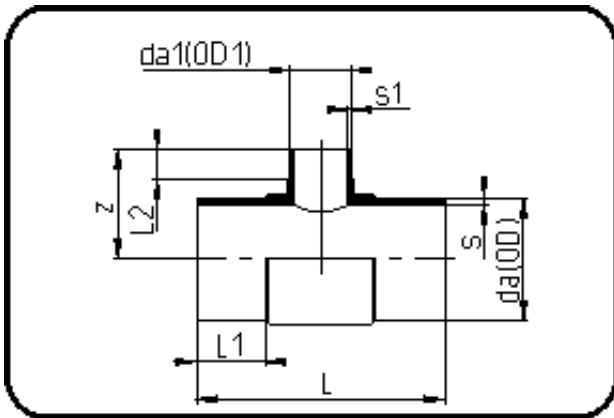

Code: 016

- Tee reduced
- short spigot
- injection moulded
- **Butt-welding**
- PPR grey

Dimension	Code	Detail	Weight
160/125	11.016.1612.17	160/125 SDR17 ISO S-8	2.04

	Unit	Nominale	Tol+	Tol-
da(OD)	mm	160	1.50	0.00
L	mm	315	4.50	4.50
L1	mm	62	3.75	3.75
L2	mm	48	3.75	3.75
s	mm	9,5	1.10	0.00
s1	mm	7,4	0.90	0.00
da(OD1)	mm	125	1.20	0.00
z	mm	150	4.50	4.50