

MULTI Fittings

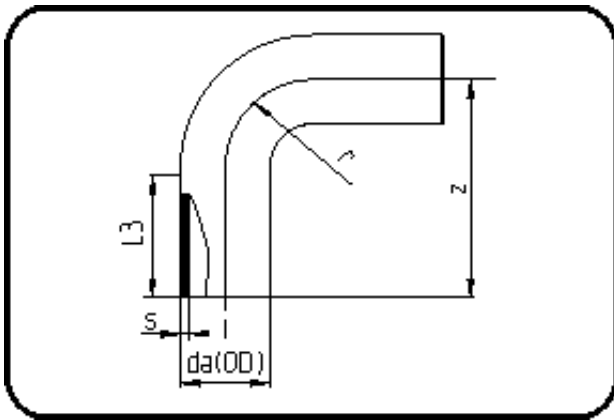

Code: 068

- **MULTI-Bend 90°**
- long spigot
- injection moulded
- **Butt + E-socket-welding**
- **PPR grey**

Dimension	Code	Detail	Weight
125	11.068.0125.11	125X11,4 SDR11 ISO S-5	1.64

	Unit	Nominale	Tol+	Tol-
da(OD)	mm	125	1.20	0.00
L3	mm	92	4.50	4.50
r	mm	125	0.00	0.00
s	mm	11,4	1.30	0.00
z	mm	218	6.00	6.00