

MULTI Fittings

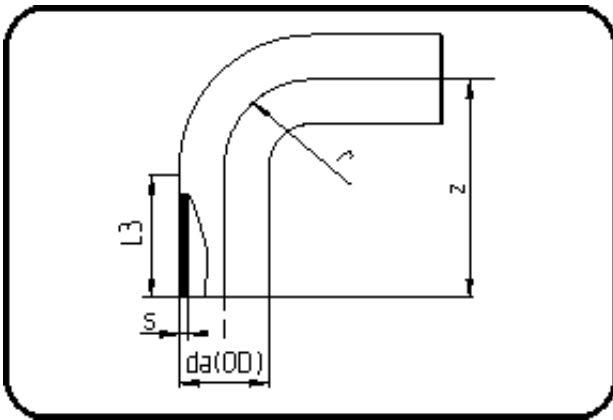

Code: 068

- **MULTI-Bend 90°**
- long spigot
- electrically conductive
- injection moulded
- **Butt + E-socket-welding**
- **PE 100-el black**

Dimension	Code	Detail	Weight
110	28.068.0110.17	110X6,6 SDR17 ISO S-8	0.87

	Unit	Nominale	Tol+	Tol-
da(OD)	mm	110	1.00	0.00
L3	mm	82	3.00	3.00
r	mm	110	0.00	0.00
s	mm	6,6	0.80	0.00
z	mm	192	6.00	6.00