

## MULTI Fittings

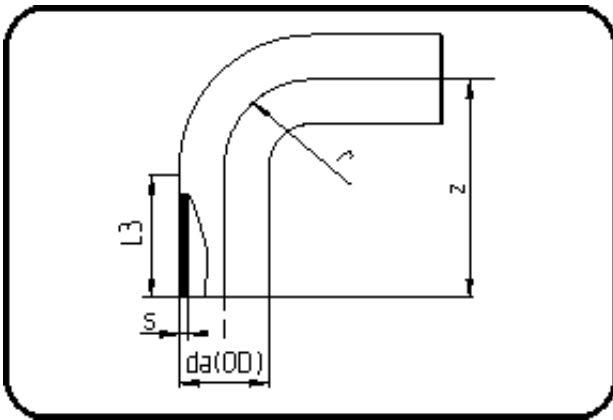

Code: 068

- **MULTI-Bend 90°**
- long spigot
- injection moulded
- **Butt + IR-welding**
- **PVDF natural**

Dimension	Code	Detail	Weight
140	30.068.0140.33	140X4,3 SDR33 ISO S-16	1.39

	Unit	Nominale	Tol+	Tol-
da(OD)	mm	140	0.80	0.00
L3	mm	75	1.50	1.50
r	mm	140	0.00	0.00
s	mm	4,3	0.70	0.00
z	mm	216	1.00	1.00