

PE 100-RC Poly-Flo

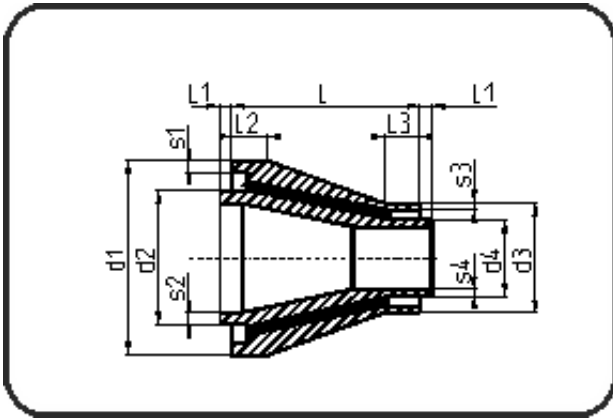

Code: 198

- Poly-Flo Reducer
- concentric
- machined
- **simultaneous + cascade welding**
- PE 100-RC black

Dimension	Code	Detail	Weight
110/63	70.198.1163.37	160/110-90/63 SDR33/17	1.05

	Unit	Nominale	Tol+	Tol-
L	mm	155	3.00	3.00
L1	mm	10	1.50	1.50
L3	mm	29	3.00	3.00
L2	mm	30	3.00	3.00
d1	mm	160	2.25	0.00
d3	mm	90	1.35	0.00
s2	mm	6,6	0.80	0.00
d2	mm	110	1.50	0.00
s1	mm	4,9	0.60	0.00
s4	mm	3,6	0.50	0.00
d4	mm	63	0.90	0.00
s3	mm	2,3	0.40	0.00