

## MULTI Fittings

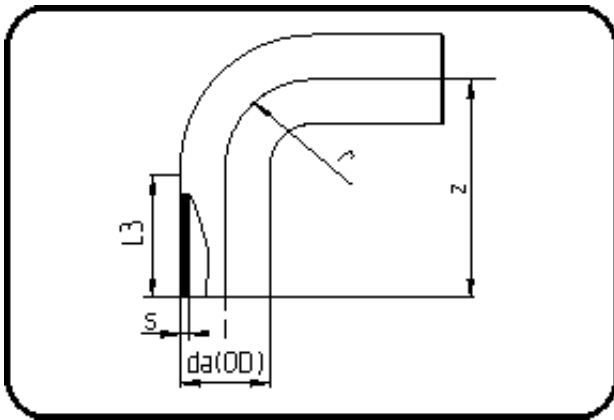

Code: 068

- **MULTI-Bend 90°**
- long spigot
- injection moulded
- **Butt + E-socket-welding**
- **PPR grey**

Dimension	Code	Detail	Weight
75	11.068.0075.11	75X6,8 SDR11 ISO S-5	0.40

	Unit	Nominale	Tol+	Tol-
da(OD)	mm	75	0.70	0.00
L3	mm	75	3.00	3.00
r	mm	75	0.00	0.00
s	mm	6,8	0.80	0.00
z	mm	150	4.50	4.50