

PE 100-RC Poly-Flo

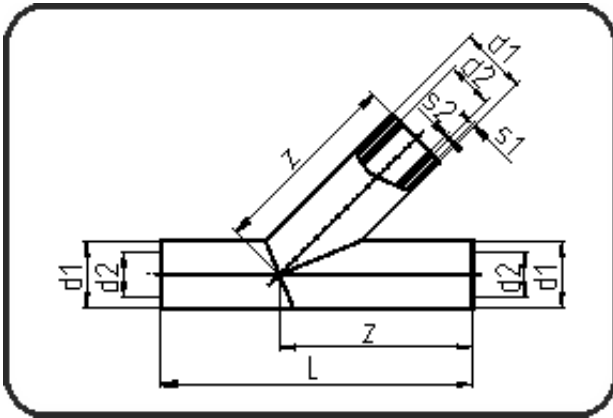

Code: 192.1

- Poly-Flo Lateral
- derating factor 0.5
- segmented
- **simultaneous + cascade welding**
- PE 100-RC black

Dimension	Code	Detail	Weight
90/63	70.192.9064.71	90/63 SDR17/11	1.49

	Unit	Nominale	Tol+	Tol-
L	mm	400	10.00	10.00
d1	mm	90	0.00	0.00
s2	mm	5,8	0.00	0.00
d2	mm	63	0.00	0.00
s1	mm	5,4	0.00	0.00
z	mm	250	5.00	5.00