

## PP/PP Simultaneous Welding

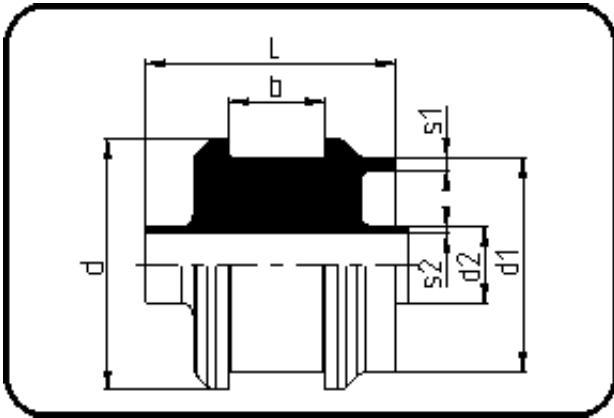

Code: 138

- Dog Bone Type II-A, Collar
- with connection to single-pipe
- machined
- **Simultaneous-welding**
- **PP/PP**

Dimension	Code	Detail	Weight
315/200	80.138.3120.31	315/200 SDR33/11	5.30

	Unit	Nominale	Tol+	Tol-
L	mm	150	1.50	1.50
b	mm	65	0.00	0.00
d	mm	340	0.00	0.00
d1	mm	315	0.00	0.00
SDR2		11	0.00	0.00
SDR1		33	0.00	0.00
s2	mm	18,2	0.00	0.00
d2	mm	200	0.00	0.00
s1	mm	9,7	0.00	0.00