

Segmented Fittings

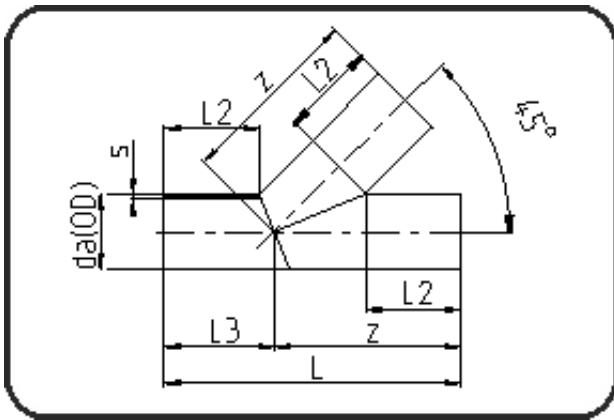

Code: 325

- Tee 45°
- segmented
- derating factor 0.5
- **Butt + E-socket-welding**
- PPH grey

Dimension	Code	Detail	Weight
250	12.325.0250.17	250X14,2 SDR17,6 ISO S-8,3	13.70

	Unit	Nominale	Tol+	Tol-
da(OD)	mm	250	0.00	0.00
L	mm	984	15.00	15.00
L3	mm	352	0.00	0.00
L2	mm	300	0.00	0.00
s	mm	14,2	0.00	0.00
z	mm	602	15.00	15.00