

PE 100-RC Poly-Flo

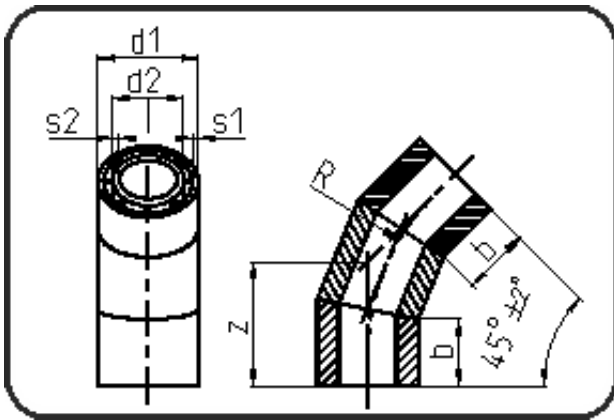

Code: 213

- Poly-Flo Elbow 45°
- 3 segments
- derating factor 0.8
- segmented
- **simultaneous + cascade welding**
- PE 100-RC black

Dimension	Code	Detail	Weight
160/110	70.213.1611.37	160/110 SDR33/17	1.31

	Unit	Nominale	Tol+	Tol-
L1	mm	10	1.50	1.50
b	mm	70	4.50	4.50
d1	mm	160	0.00	0.00
s2	mm	6,6	0.00	0.00
d2	mm	110	0.00	0.00
s1	mm	4,9	0.00	0.00
z	mm	151	9.00	9.00