

Seal Clean Gaskets

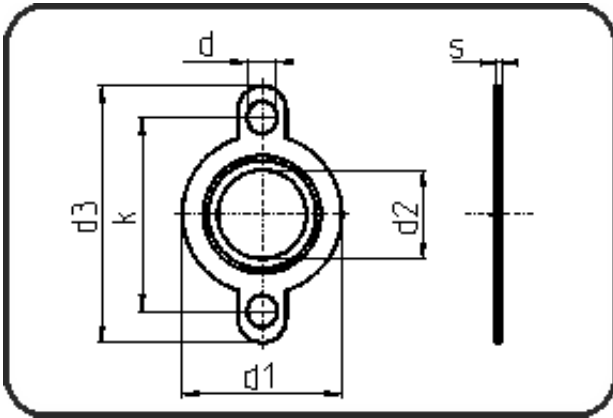

Code: 372.4

- Seal Clean Gasket
- ANSI
- for AGRU PVDF flanges
- Flange connection
- ePTFE white

Dimension	Code	Detail	Weight
200	88.372.4200.21	200 - SDR21 ANSI	0.04

	Unit	Nominale	Tol+	Tol-
s	mm	3	0.50	0.50
d	mm	22	1.00	0.00
d1	mm	268	1.50	1.50
d3	mm	336,45	1.50	1.50
d2	mm	162,5	1.00	1.00
k	mm	298,45	1.00	1.00