

Valves

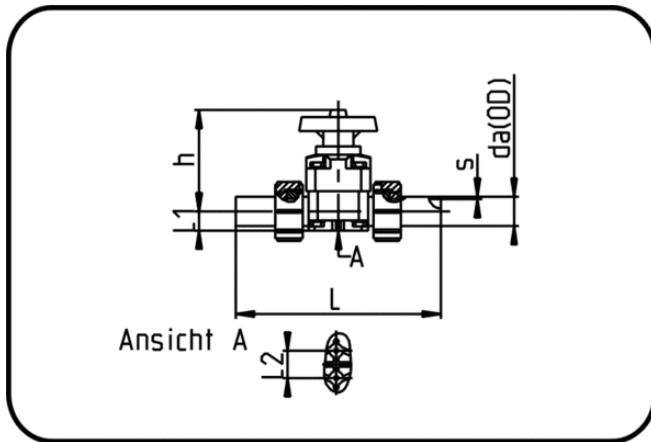

Code: 340

- Diaphragm Valve
- manually controlled
- EPDM/PTFE diaphragm
- Union Connection
- PVDF UHP natural

Dimension	Code	Detail	da(OD) mm	s mm	L mm	L1 mm	L2 mm	h mm	Weight
20	35.340.0020.21	20 - SDR21 MOP 10 bar	20	1,9	198	16,5	24,5	100	0.60
25	35.340.0025.21	25 - SDR21 MOP 10 bar	25	1,9	222	16,5	24,5	100	0.63
32	35.340.0032.21	32 - SDR21 MOP 10 bar	32	2,4	236	20,1	24,5	107	0.92
40	35.340.0040.21	40 - SDR21 MOP 10 bar	40	2,4	260	25,5	44	144	1.86
50	35.340.0050.21	50 - SDR21 MOP 10 bar	50	3	286	32	44	144	2.13
63	35.340.0063.21	63 - SDR21 MOP 10 bar	63	3	322	38,5	44	170	3.21