

MULTI Fittings

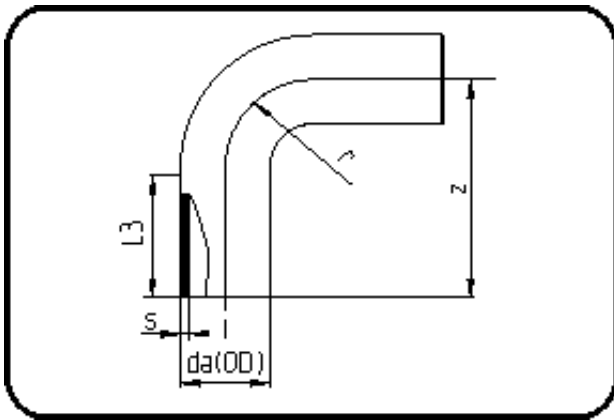

Code: 068

- **MULTI-Bend 90°**
- long spigot
- electrically conductive
- injection moulded
- **Butt + E-socket-welding**
- **PE 100-el black**

Dimension	Code	Detail	Weight
125	28.068.0125.17	125X7,4 SDR17 ISO S-8	1.27

	Unit	Nominale	Tol+	Tol-
da(OD)	mm	125	1.20	0.00
L3	mm	92	3.00	3.00
r	mm	125	0.00	0.00
s	mm	7,4	0.90	0.00
z	mm	218	4.00	4.00