

Seal Clean Gaskets

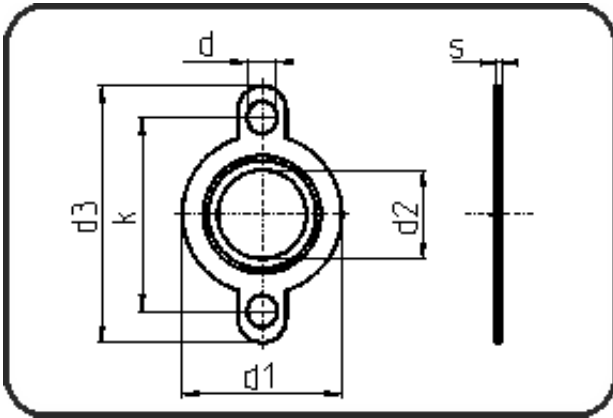

Code: 372.4

- Seal Clean Gasket
- ANSI
- for AGRU PVDF flanges
- Flange connection
- ePTFE white

Dimension	Code	Detail	Weight
125	88.372.4125.33	125 - SDR33 ANSI	0.02

	Unit	Nominale	Tol+	Tol-
s	mm	3	0.50	0.50
d	mm	20	1.00	0.00
d1	mm	158	1.50	1.50
d3	mm	224,5	1.50	1.50
d2	mm	115,5	1.00	1.00
k	mm	190,5	1.00	1.00