

Backing Rings, Accessories

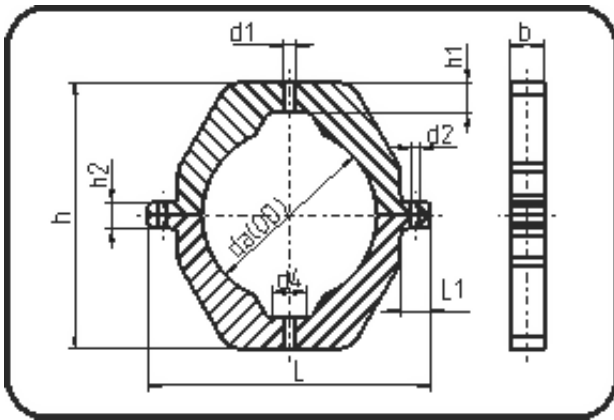

Code: 348.4

- Pipe Clip
- 2 halves / without screws
- machined
- **Installation Accessory**
- PPR grey

Dimension	Code	Detail	Weight
280	11.348.4280.00	280x40mm	0.90

	Unit	Nominale	Tol+	Tol-
da(OD)	mm	280	0.00	0.00
L	mm	410	1.50	1.50
L1	mm	35	2.25	0.00
h1	mm	36	0.75	0.75
b	mm	40	2.25	2.25
h2	mm	30	1.50	1.50
d1	mm	14	0.75	0.00
d2	mm	10	0.75	0.75
h	mm	392	1.50	1.50
d4	mm	40	0.00	2.25