

PE/PVDF Staggered Welding

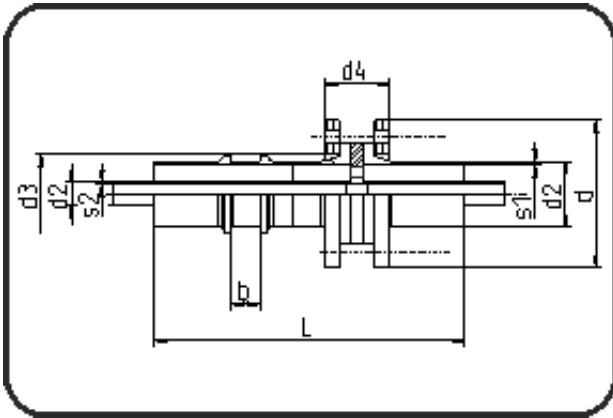

Code: 249

- Dog Bone Type III, Collar
- with cut out
- machined
- Staggered + E-socket-welding
- HDPE/PVDF

Dimension	Code	Detail	Weight
200/110	84.249.2011.73	200/110 SDR17/33	13.91

	Unit	Nominale	Tol+	Tol-
L	mm	640	3.00	3.00
SDR2		33	0.00	0.00
SDR1		17	0.00	0.00
s2	mm	3,4	0.60	0.00
s1	mm	11,9	1.40	0.00
b	mm	60	63.00	60.00
numb	pc	8	0.00	0.00
d	mm	341	1.50	1.50
d1	mm	200	2.70	0.00
d3	mm	235	1.50	0.00
d2	mm	110	1.50	0.00
K	mm	M20	0.00	0.00
d4	mm	116	0.00	0.00