

MULTI Fittings

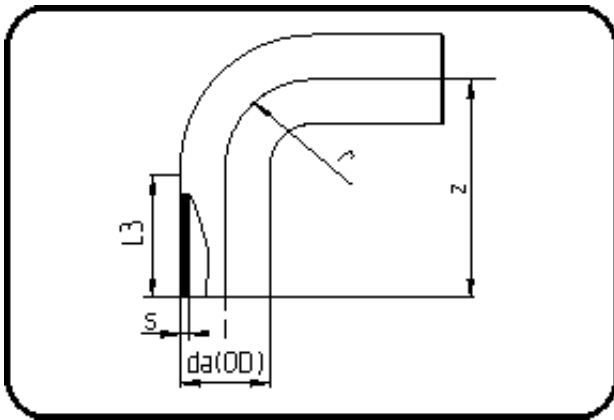

Code: 068

- **MULTI-Bend 90°**
- long spigot
- injection moulded
- **Butt + E-socket-welding**
- **PPR grey**

Dimension	Code	Detail	Weight
90	11.068.0090.11	90X8,2 SDR11 ISO S-5	0.66

	Unit	Nominale	Tol+	Tol-
da(OD)	mm	90	0.90	0.00
L3	mm	76	3.00	3.00
r	mm	90	0.00	0.00
s	mm	8,2	1.00	0.00
z	mm	168	4.50	4.50