

Fittings with short Spigot

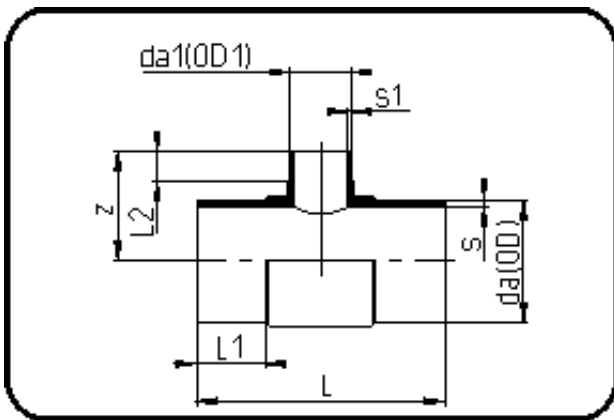

Code: 016

- Tee reduced
- short spigot
- injection moulded
- **Butt-welding**
- PPR grey

Dimension	Code	Detail	Weight
180/75	11.016.1875.11	180/75 SDR11 ISO S-5	3.10

	Unit	Nominale	Tol+	Tol-
da(OD)	mm	180	1.70	0.00
L	mm	366	4.50	4.50
L1	mm	123	3.75	3.75
L2	mm	31	1.50	1.50
s	mm	16,4	1.80	0.00
s1	mm	6,8	0.80	0.00
da(OD1)	mm	75	0.70	0.00
z	mm	148	3.00	3.00