

PE 100-RC Poly-Flo

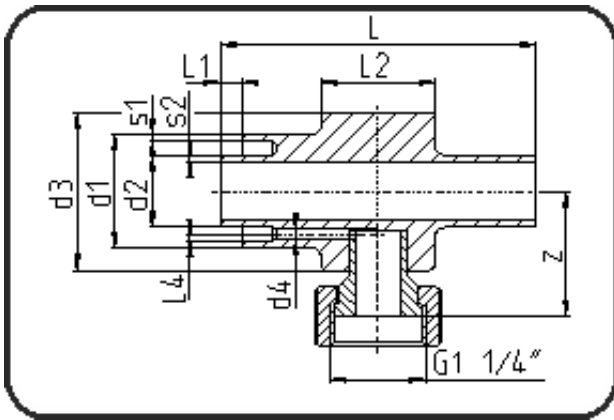

Code: 196.1

- Poly-Flo Measuring Fitting
- with transition to single tube
- machined
- **simultaneous + cascade welding**
- PE 100-RC black

Dimension	Code	Detail	Weight
160/110	70.196.1612.37	160/110 SDR33/17	1.10

	Unit	Nominale	Tol+	Tol-
L	mm	140	2.25	2.25
L1	mm	10	0.75	0.75
L2	mm	0	0.00	0.00
d1	mm	160	2.25	0.00
d3	mm	160	0.75	0.00
s2	mm	6,6	1.20	0.00
d2	mm	110	1.50	0.00
s1	mm	4,9	1.20	0.00
z	mm	100	3.75	3.75