

PE 100-RC Poly-Flo

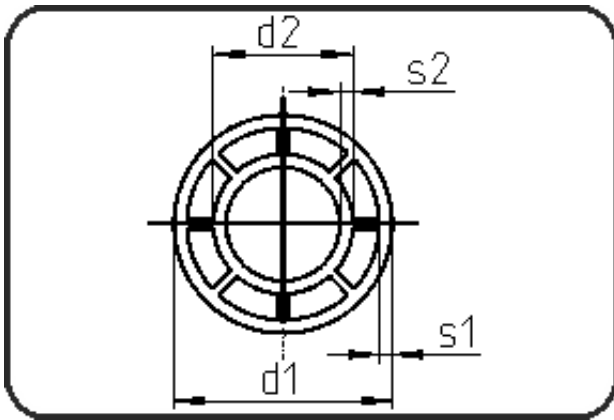

Code: 785.1

- Poly-Flo Pipe 5m (16.4')
- extruded
- **simultaneous + cascade welding**
- PE 100-RC black

Dimension	Code	Detail	Weight
90/63	70.785.9063.71	90/63 SDR17/11	2.65

	Unit	Nominale	Tol+	Tol-
d1	mm	90	0.90	0.00
s2	mm	5,8	0.70	0.00
d2	mm	63	0.60	0.00
s1	mm	5,4	0.70	0.00