

PE 100-RC Poly-Flo

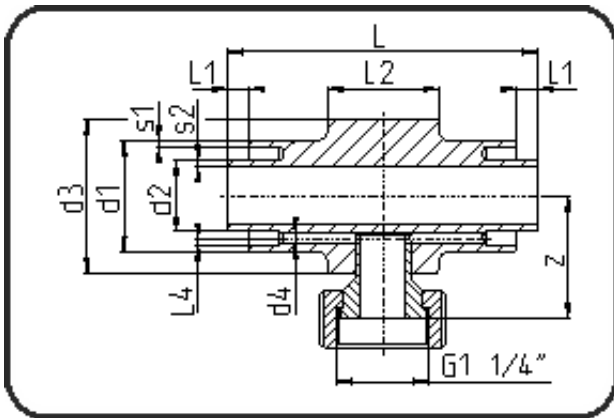

Code: 196.2

- Poly-Flo Measuring Fitting
- both side leakage control
- machined
- **simultaneous + cascade welding**
- PE 100-RC black

Dimension	Code	Detail	Weight
90/63	70.196.9065.71	90/63 SDR17/11	0.61

	Unit	Nominale	Tol+	Tol-
L	mm	140	4.50	4.50
L1	mm	10	1.50	1.50
L2	mm	50	3.00	3.00
d1	mm	90	1.35	0.00
d3	mm	102	1.50	0.00
s2	mm	5,8	0.70	0.00
d2	mm	63	0.90	0.00
s1	mm	5,4	0.70	0.00
z	mm	71	7.50	7.50